

DPDT Waveguide Switch

Latching, 10 to 15 GHz, WR-75

Model: TWS-WR75

Electrical Characteristics:

Parameter	Min	Typ	Max	Unit
Frequency Range	10		15	GHz
Control Mode	Latching, Manual/Electric			
Switching time@TEM=25°C			50	ms
Standard Actuator Life	100000			Cycles
Actuator voltage Available		24		V DC
Actuator current		1		A

RF Specifications:

Parameter	Min	Typ	Max	Unit
Frequency Range	10		15	GHz
Insertion Loss			0.1	dB
Isolation	70			dB
VSWR			1.1	:1

Environmental And Physical Characteristics:

Parameter	Condition
Operating Temperature	-40°C to +70°C
Non-operating Temperature	-50°C to +80°C
Vibration(operating)	10G RMS, 20-2000HZ
Shock(non operating)	50G, 1/2Sine, 12msec
Connector Type	WR-75
Control Connector	TYB3112E10-6P

Outline Drawing:

Unit: mm

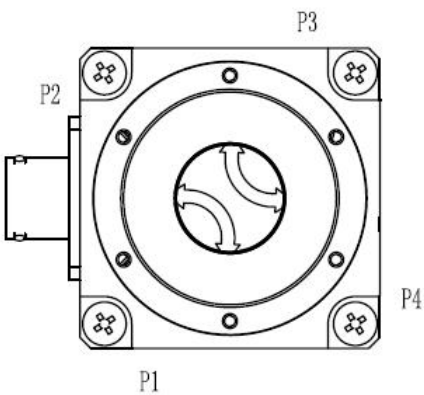
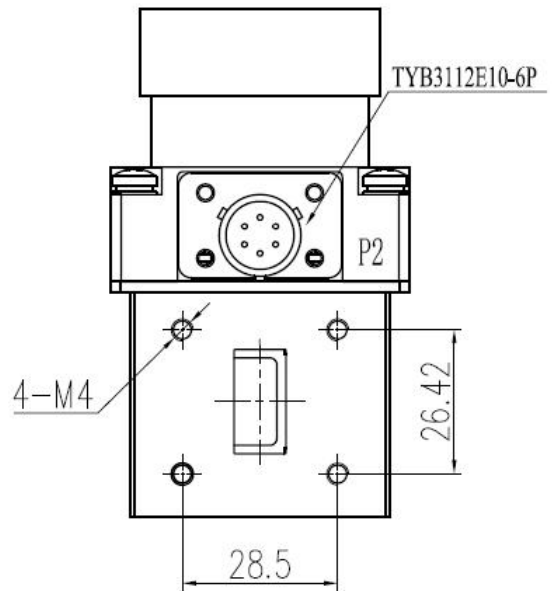
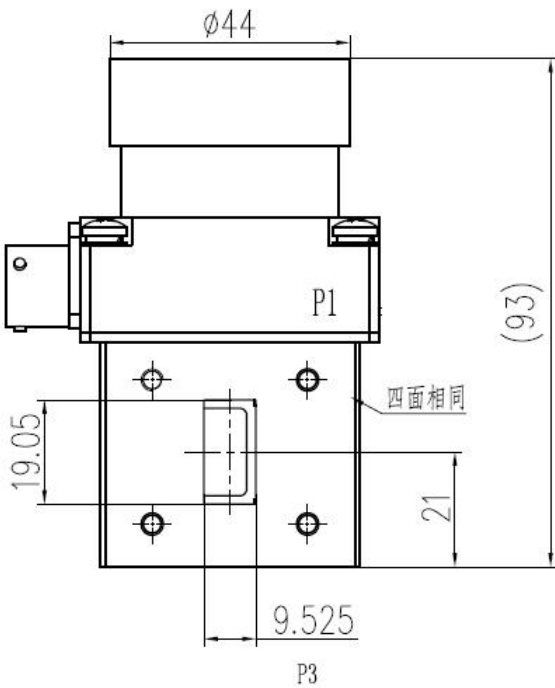
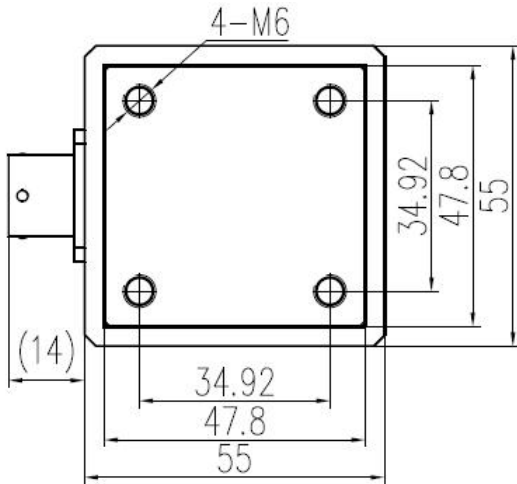

Schematic:

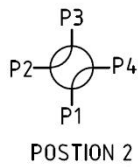
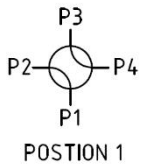

MS3221E10-6P		RF Connect Used
Pin NO	FUNCTION	DPDT
A	V1 POSTION1	POS1:P1-P2,P3-P4
B	GND	
C	V2 POSTION2	POS2:P1-P4,P2-P3
D	IND POSTION1	D-E ON; E-F OFF
E	IND COM	
F	IND POSTION2	D-E OFF;E-F ON

Outline Drawing:

Part Number	Actuator voltage	Revision
TWS-WR75	24 V	Rev.1.0