

DPDT Waveguide Switch

Latching, 40 to 59 GHz, WR-18

Model: TWS-WR18

电气参数 Electrical Characteristics:

参数 Parameter	Min	Typ	Max	单位 Unit
频率范围 Frequency Range	40		59	GHz
控制模式 Control Mode	Latching, Manual/Electric			
切换时间 Switching time@TEM=25°C			50	ms
开关寿命 Standard Actuator Life	100000			Cycles
驱动电压 Actuator voltage Available		24		V DC
驱动电流 Actuator current		1		A

射频特性 RF Specifications:

参数 Parameter	Min	Typ	Max	单位 Unit
频率范围 Frequency Range	40		59	GHz
插损 Insertion Loss			0.2	dB
隔离 Isolation	50			dB
驻波 VSWR			1.2	:1

环境和物理特性 Environmental And Physical Characteristics:

参数 Parameter	条件 Condition
操作温度 Operating Temperature	-40°C to +70°C
存储温度 Non-operating Temperature	-50°C to +80°C
震动 Vibration(operating)	10G RMS, 20-2000HZ
冲击 Shock(non operating)	50G, 1/2Sine, 12msec
射频接口 Connector Type	WR-18
控制接口 Control Connector	TYB3112E10-6P

外形尺寸 Outline Drawing:

Unit: mm

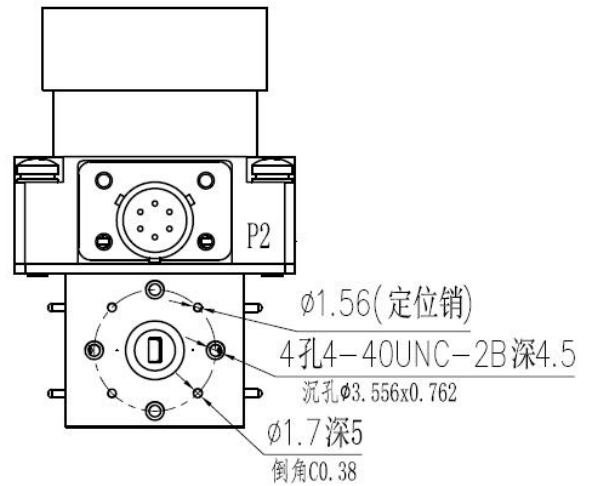
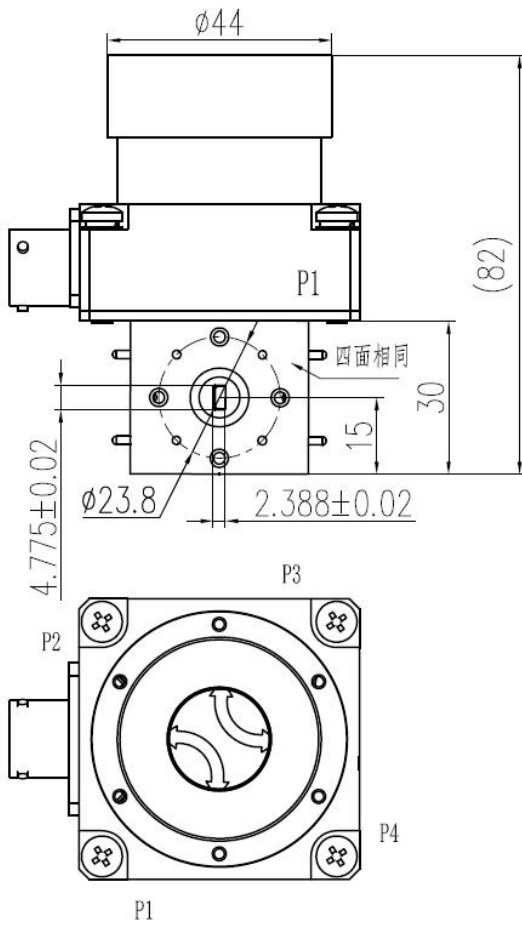
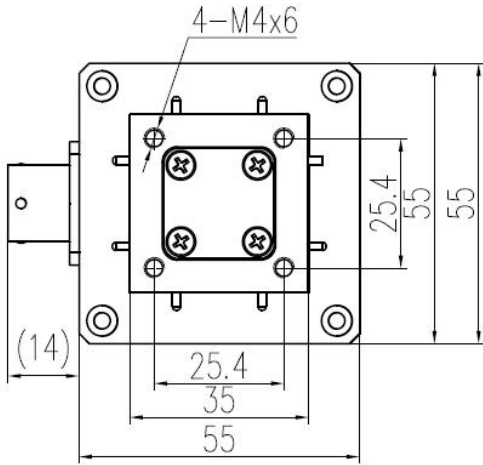

原理图 Schematic:



MS3221E10-6P		RF Connect Used
Pin NO	FUNCTION	DPDT
A	V1 POSTION1	POS1:P1-P2,P3-P4
B	GND	
C	V2 POSTION2	POS2:P1-P4,P2-P3
D	IND POSTION1	D-E ON; E-F OFF
E	IND COM	
F	IND POSTION2	D-E OFF;E-F ON

标准型号 Outline Drawing:

标准型号 Part Number	驱动电压 Actuator voltage	版本号 Revision
TWS-WR18	24 V	Rev.1.0